

PROIZVODI OD RECIKLIRANE PLASTIKE  
RECYCLED PLASTIC PRODUCTS



**GELAX**  
signalizacija & urbana oprema

[www.gelax.hr](http://www.gelax.hr)

# GELAX

signalizacija & urbana oprema

## ROTOR / ROUNDABOUT

PROIZVOD OD RECIKLIRANE PLASTIKE / RECYCLED PLASTIC PRODUCT



MOGUĆNOST SASTAVLJANJA U RAZLIČITE DIMENZIJE  
JEDNOSTAVNA MONTAŽA  
JEDNOSTAVNA DEMONTAŽA  
DUGOTRAJNO  
RECIKLIRAJUĆE

MODULAR IN DIFFERENT SIZES  
EASY TO INSTALL  
EASY TO REMOVE  
LONG LASTING  
RECYCABLE



[www.gelax.hr](http://www.gelax.hr)

Zanatska 4, Plovanija  
52460 Buje /Croatia/

Tel/Fax: 00385 (0)52 777 144  
e-mail: [gelax@pu.htnet.hr](mailto:gelax@pu.htnet.hr)

## TEHNIČKI OPIS / TECHNICAL CARD

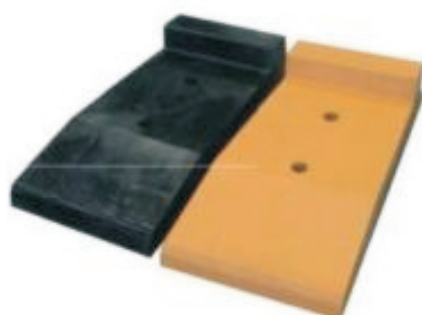

Rotor od mobilnih elemenata realizirana od reciklirajuće plastike

Mogućnost izvedbe u različitim dimenzijama

Jednostavna montaža u zemlju primjenom metalnih vijaka

Recycled plastic roundabout with movable components

Different sizes available

Simple installation by fixing metal pins to the ground

X = Varijabilne dimenzije u funkciji promjera  
X = Variable dimension in function of the diameter

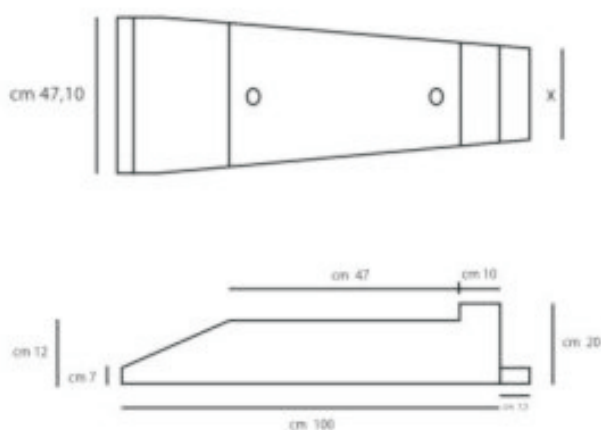

### DOSTUPNI PROMJERI / AVAILABLE DIAMETERS

VANJSKI EXTERNAL	UNUTANJI INTERNAL	X	MODUL MODULARS	X	MODUL MODULARS	POTPUNI MODUL TOTAL MODULARS
mt	mt	cm	pz	cm	pz	pz.
5,1	3,1	28,6	34			34
6,6	4,6	28,6	22	37,6	22	44
7,2	5,2	28,6	24	39,3	24	48
7,65	5,65	28,6	26	41,2	26	52
8,3	6,3	28,6	28	42,4	28	56
9,9	7,9	37,6	66			66
12	10	39,3	80			80
13,8	11,8	37,6	46	43,3	46	92
15	13	39,3	50	41,9	50	100
15,9	13,9	41,2	106			106
18	16	41,9	120			120
20,1	18,1	42,4	134			134
24	22	43,3	160			160



## RUBNIK ZA PROMETNE I ZELENE OTOKE / CENTRAL RESERVATIONS AND FLOBERBEDS KERB

PROIZVOD OD RECIKLIRANE PLASTIKE / RECYCLED PLASTIC PRODUCT



IDEALNO RIJEŠENJE ZA PROMETNE OTOKE  
JEDNOSTAVNA MONTAŽA  
JEDNOSTAVNO UKLANJANJE  
DUGOTRAJNO  
RECIKLIRAJUĆE

IDEAL SOLUTION FOR PARKINGS AND GARAGES  
EASY TO INSTALL  
EASY TO REMOVE  
LONG LASTING  
RECYCABLE



Zanatska 4, Plovanija  
52460 Buje /Croatia/

Tel/Fax: 00385 (0)52 777 144  
e-mail: gelax@pu.htnet.hr



**TEHNIČKI OPIS / TECHNICAL CARD****RUBNJAK**

**DIMENZIJA** - cm 100x13xh14  
**TEŽINA** - kg 11,50

**BOJE**  
crno - žuto - bijela  
žuto/crna - bijelo/crna

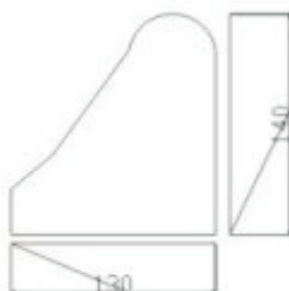
**KERB**

**SIZE** - cm 100x13xh14  
**WEIGHT** - kg 11,50

**COLOURS**  
black - yellow - white  
yellow/black - white/black

**KRIVULJE**

**RADIJUS** cm 30 - cm 60x13xh14  
**TEŽINA** - kg 6,00  
**BOJE**  
crno - žuto - bijela

**RADIJUS** cm 50 - cm 100x13xh14  
**TEŽINA** - kg 11,00  
**BOJE**  
crno - žuto - bijela

**CURVES**

**RADIUS** cm 30 - cm 60x13xh14  
**WEIGHT** - kg 6,00

**COLOURS**  
black - yellow - white

**RADIUS** cm 30 - cm 60x13xh14  
**WEIGHT** - kg 6,00

**COLOURS**  
black - yellow - white

# GELAX

signalizacija & urbana oprema

## RUBNIK JOLLY / JOLLY KERB

PROIZVOD OD RECIKLIRANE PLASTIKE / RECYCLED PLASTIC PRODUCT



IDEALAN ZA IZRADU ROTORA  
IDEALAN ZA IZRADU RUBNIH DJELOVA NOGOSTUPA  
JEDNOSTAVNA MONTAŽA  
JEDNOSTAVNA DEMONTAŽA  
DUGOTRAJNO  
RECIKLIRAJUĆ

IDEAL SOLUTION FOR THE BUILDING UP OF ROUNDABOUTS  
IDEAL SOLUTION FOR PAVEMENTS  
EASY TO INSTALL  
EASY TO REMOVE  
LONG LASTING  
RECYCABLE



[www.gelax.hr](http://www.gelax.hr)

Zanatska 4, Plovanija  
52460 Buje /Croatia/

Tel/Fax: 00385 (0)52 777 144  
e-mail: [gelax@pu.hinet.hr](mailto:gelax@pu.hinet.hr)

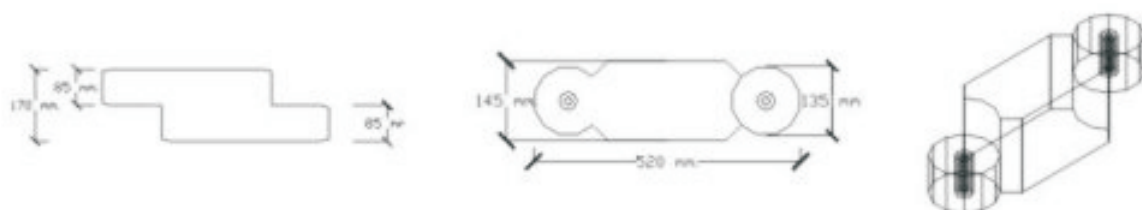
**TEHNIČKI OPIS / TECHNICAL CARD****RUBNIK JOLLY**

Dimenzije - cm 52 x 14,5 x h17  
1 mt = 2,5 komada

Težina - Kg 5,950  
Boja - Crna - Žuta - Bijela

**JOLLY KERB**

Size - cm 52 x 14,5 x h17  
1 mt = 2,5 komada

Weight - Kg 5,950  
Colours - Crna - Žuta - Bijela





# GELAX

signalizacija & urbana oprema

## UZDIGNUTI PJEŠAČKI PRIJELAZ / ELEVATED PEDESTRAIN CROSSING PROIZVOD OD RECIKLIRANE PLASTIKE / RECYCLED PLASTIC PRODUCT



SASTAVLJIVO U SVIM DIMENZIJAMA  
JEDNOSTAVNA MONTAŽA  
JEDNOSTAVNA DEMONTAŽA  
SA REFLEKTIRAJUĆIM PLASTIČNIM LAMINATOM  
DUGOTRAJNO  
RECIKLIRAJUĆ

MODULAR IN ALL SIZE  
EASY TO INSTALL  
EASY TO REMOVE  
WITH REFLECTIVE LAMINATED PLASTIC  
LONG LASTING  
RECYCABLE



[www.gelax.hr](http://www.gelax.hr)

Zanatska 4, Plovanija  
52460 Buje /Croatia/

Tel/Fax: 00385 (0)52 777 144  
e-mail: [gelax@pu.hinet.hr](mailto:gelax@pu.hinet.hr)

**TEHNIČKI OPIS / TECHNICAL CARD**

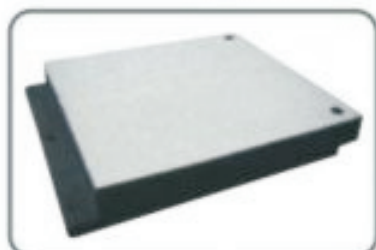

**Bijeli modul**  
cm 50x50x7h

**White modul**  
cm 50x50x7h

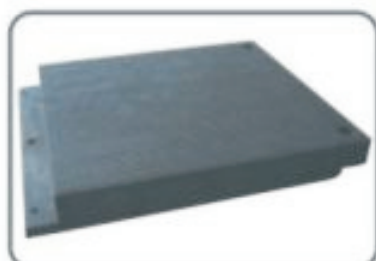

**Crni modul**  
cm 50x50x7h

**Black modul**  
cm 50x50x7h

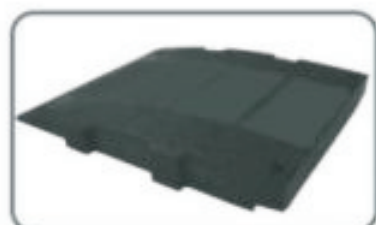

**Završetak «ženski»**  
cm 50 x 60 x 7h

**Female convex  
profile and cap**  
cm 50 x 60 x 7h



**Završetak «muški»**  
cm 50 x 60 x 7h

**Male convex  
profile and cap**  
cm 50 x 60 x 7h

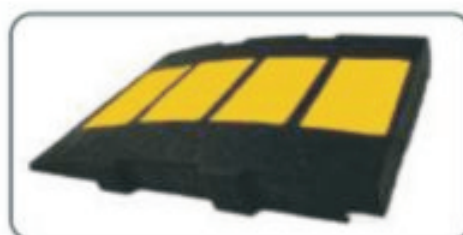

**Završetak «muški» crno/žuti**  
giallo / nero cm 50 x 60 x 7h

**Male black/yellow convex profile and cap**  
cm 50 x 60 x 7h



**Završetak «ženski» crno/žuti**  
giallo / nero cm 50 x 60 x 7h

**Female black/yellow convex  
profile and cap**  
cm 50 x 60 x 7h

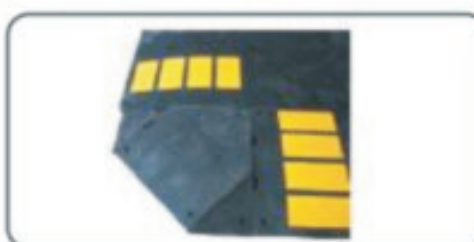

**Kutni crno/žuti**  
cm 50 x 60 circa x 7h

**Corner black/yellow**  
cm 50 x 60 about x 7h

# GELAX

signalizacija & urbana oprema

## RUBNIK ZA RAZDVAJANJE BICIKLISTIČKIH STAZA BICYCLE PATH SEPARATOR KERB

PROIZVOD OD RECIKLIRANE PLASTIKE / RECYCLED PLASTIC PRODUCT



IDEALAN GRANIČNIK BICIKLISTIČKIH STAZA  
JEDNOSTAVNA MONTAŽA  
JEDNOSTAVNA DEMONTAŽA  
DUGOTRAJNO  
RECIKLIRAJUĆ

IDEAL TO DELIMIT THE CYCLE PATH  
EASY TO INSTALL  
EASY TO REMOVE  
LONG LASTING  
RECYCABLE



[www.gelax.hr](http://www.gelax.hr)

Zanatska 4, Plovanija  
52460 Buje /Croatia/

Tel/Fax: 00385 (0)52 777 144  
e-mail: [gelax@pu.hinet.hr](mailto:gelax@pu.hinet.hr)



**TEHNIČKI OPIS / TECHNICAL CARD****RUBNIK**

**DUŽINA** - cm 100  
**ŠIRINA** - cm 14,5  
**VISINA** - cm 11,5  
**TEŽINA** - kg 12,1  
**BOJA** - crno/žuto

sa žutim reflektirajućim trakama

**KERB**

**LEINGHT** - cm 100  
**WIDTH** - cm 14,5  
**HEIGHT** - cm 11,5  
**WEIGHT** - kg 12,1  
**COLOURS** - black/yellow

with reflective film

**ZAOBLJENI RUBNIK**

**PROMJER** - cm 23,5  
**TEŽINA** - kg 7  
**BOJA** - žuto

sa žutim reflektirajućim trakama

**CURVE**

**RADIUS** - cm 23,5  
**WEIGHT** - kg 7  
**COLOURS** - yellow

with reflective film

**SREDNJI UNUTARNJI  
MODUL**

**DUŽINA** - cm 99  
**ŠIRINA** - cm 24  
**VISINA** - cm 11,5  
**TEŽINA** - kg 12,1  
**BOJA** - crno

**INTERMEDIATE  
INTERNAL MODULAR**

**LEINGHT** - cm 99  
**WIDTH** - cm 24  
**HEIGHT** - cm 11,5  
**WEIGHT** - kg 12,1  
**COLOURS** - black

**ZAVRŠNI UNUTARNJI  
MODUL**

**DUŽINA** - cm 61,5  
**ŠIRINA** - cm 24  
**VISINA** - cm 11,5  
**TEŽINA** - kg 6,8  
**BOJA** - crno

**FINAL INTERNAL  
MODULAR**

**LEINGHT** - cm 61,5  
**WIDTH** - cm 24  
**HEIGHT** - cm 11,5  
**WEIGHT** - kg 6,8  
**COLOURS** - black

# GELAX

signalizacija & urbana oprema

## STOP PARKING

PROIZVOD OD RECIKLIRANE PLASTIKE / RECYCLED PLASTIC PRODUCT



IDEALAN ZA PARKIRALIŠTA I GARAŽE  
JEDNOSTAVNA MONTAŽA  
JEDNOSTAVNA DEMONTAŽA  
DUGOTRAJNO  
RECIKLIRAJUĆE

IDEAL SOLUTION FOR PARKINGS AND GARAGES  
EASY TO INSTALL  
EASY TO REMOVE  
LONG LASTING  
RECYCABLE



[www.gelax.hr](http://www.gelax.hr)

Zanatska 4, Plovanija  
52460 Buje /Croatia/

Tel/Fax: 00385 (0)52 777 144  
e-mail: [gelax@pu.htnet.hr](mailto:gelax@pu.htnet.hr)

## TEHNIČKI OPIS / TECHNICAL CARD



### STOP PARKING

DIMENZIJA - cm 70x16xh10

TEŽINA - kg 6,50

#### BOJE

crno - bez reflektirajuće trake

žuto - bez reflektirajuće trake

crno - sa reflektirajućom trakom



### STOP PARKING

SIZE - cm 70x16xh10

WEIGHT - kg 6,50

#### COLOURS

black - without reflective film

yellow-without reflective film

black - wit reflective film





# GELAX

signalizacija & urbana oprema

## GUMENE PREPREKE / SPEED RAMP

PROIZVOD OD RECIKLIRANE PLASTIKE / RECYCLED PLASTIC PRODUCT

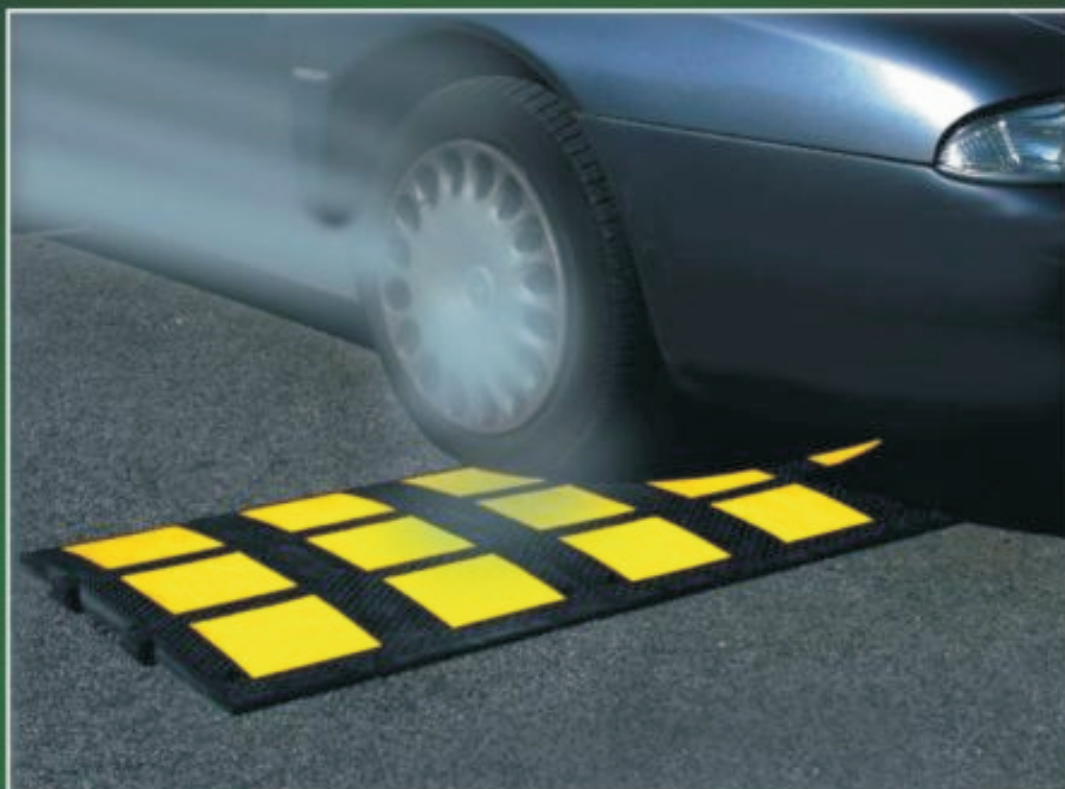

CERTIFICIRAN  
SA REFLEKTIRAJUĆOM LAMINACIJOM  
DUGOTRAJNO  
RECIKLIRAJUĆ

CERTIFIED  
WITH REFLECTICE LAMINATED PLASTIC  
LONG LASTING  
RECYCABLE



[www.gelax.hr](http://www.gelax.hr)

Zanatska 4, Plovanija  
52460 Buje /Croatia/

Tel/Fax: 00385 (0)52 777 144  
e-mail: [gelax@pu.hinet.hr](mailto:gelax@pu.hinet.hr)

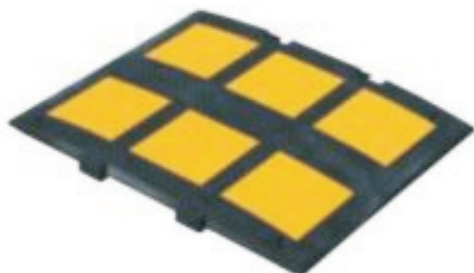
**TEHNIČKI OPIS / TECHNICAL CARD****GUMENE PREPREKE H=CM3**

Modul - cm 48,5 x 61 x 3h  
Homologacija - D.M. 25547 2006

**HIGH SPEED RAMP H=CM3**

Unit - cm 48,5 x 61 x 3h  
Certification - D.M. 25547 2006

**GUMENE PREPREKE H=CM5**

Modul - cm 50 x 90 x 5h  
Homologacija - D.M. 25552 2006

**HIGH SPEED RAMP H=CM5**

Unit - cm 50 x 90 x 5h  
Certification - D.M. 25552 2006

**ZAVRŠETAK ŽENSKI / FEMALE AND CAP**  
cm 30 x 90 x 5h

**ZAVRŠETAK MUŠKI / MALE AND CAP**  
cm 30 x 90 x 5h

**GUMENE PREPREKE H=CM7**

Homologacija - D.M. 735 2011

**HIGH SPEED RAMP H=CM7**

Certification - D.M. 735 2011

**PREPREKA ŽENSKA / FEMALE SPEED RAMP**  
Modul / Unit - cm 50 x 60 x 7h

**PREPREKA MUŠKA / MALE SPEED RAMP**  
Modul / Unit - cm 50 x 60 x 7h

**ZAVRŠETAK ŽENSKI / FEMALE AND CAP**  
cm 30 x 60 x 7h

**ZAVRŠETAK MUŠKI / MALE AND CAP**  
cm 30 x 60 x 7h

# GELAX

signalizacija & urbana oprema

## KUTNIK I ODBOJNIK / CORNER BUMP AND BUMPER PROIZVOD OD RECIKLIRANE PLASTIKE / RECYCLED PLASTIC PRODUCT



IDEALAN ZA PARKIRALIŠTA I GARAŽE  
JEDNOSTAVNA MONTAŽA  
BRZO UKLANJANJE  
DUGOTRAJNO  
RECIKLIRAJUĆ

IDEAL SOLUTIONS FOR PARKINGS AND GARAGES  
EASY TO INSTAL  
EASY TO REMOVE  
LONG LASTING  
RECYCABLE



[www.gelax.hr](http://www.gelax.hr)

Zanatska 4, Plovanija  
52460 Buje /Croatia/

Tel/Fax: 00385 (0)52 777 144  
e-mail: [gelax@pu.htnet.hr](mailto:gelax@pu.htnet.hr)



**TEHNIČKI OPIS / TECHNICAL CARD****ODBOJNIK**

U reciklirajućoj plastici

Dužina	cm 100
Širina	cm 18
Debljina	mm 14
Težina	kg 4,5

Reflektirajuće žute trake

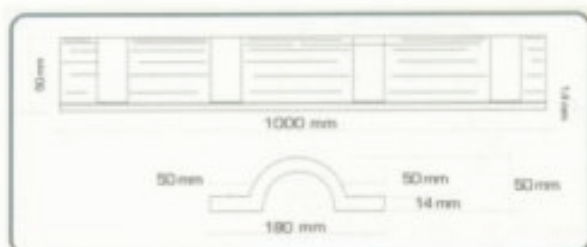
**BUMPERS**

Made of recyclable PVC

Lenght	cm 100
Width	cm 18
Thickness	mm 14
Weight	kg 4,5

With refracting sections

**KUTNIK**

U reciklirajućoj plastici

Dužina	cm 100
Širina	cm 10,5 + 10,5
Debljina	mm 14
Težina	kg 4,5

Reflektirajuće žute trake

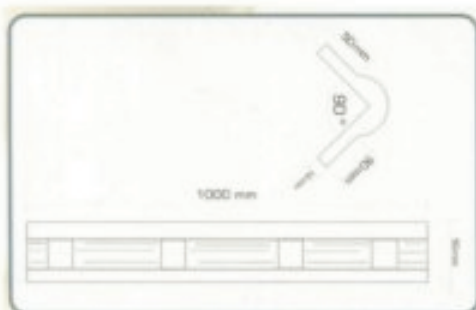
**CORNER BUMPERS**

Made of recyclable PVC

Lenght	cm 100
Width	cm 10,5 + 10,5
Thickness	mm 14
Weight	kg 4,5

With refracting sections



# GELAX

signalizacija & urbana oprema

## REFORM POSTOLJA / HEAVY BASE

PROIZVOD OD RECIKLIRANE PLASTIKE / RECYCLED PLASTIC PRODUCT



JEDNOSTAVNO RUKOVANJE  
AUTOMATSKO BLOKIRANJE  
SA REFLEKTIRAJUĆIM OZNAKAMA  
DUGOTRAJNO  
RECIKLIRAJUĆ

EASY TO HANDLE  
SELF - LOCKING  
WITH REFLECTIVE FILM  
LONG LASTING  
RECYCABLE



Zanatska 4, Plovanija  
52440 Buje /Croatia/

Tel/Fax: 00385 (0)52 777 144  
e-mail: gelax@pu.htnet.hr

[www.gelax.hr](http://www.gelax.hr)

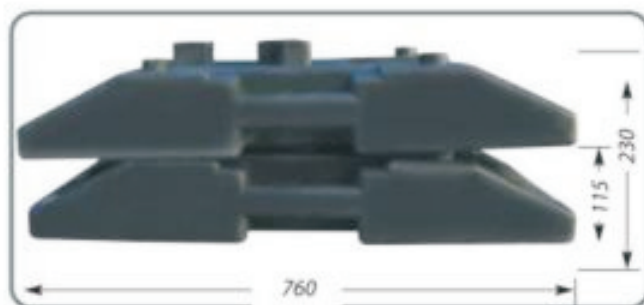
**TEHNIČKI OPIS / TECHNICAL CARD****TEHNIČKE KARAKTERISTIKE****TEŽINA**

Mod: 01:15 kg

Mod: 10:27 kg

**DIMENZIJE**

mm 340 x 760 x 115 h

**PREDVIĐENO ZA PVC STUPOVE** ☑

30 x 30 mm 50 x 50 mm 60 x 60 mm

**KUČIŠTE ZA BATERIJU**

mm 180 x 150 x 150 h

**TECHNICAL FEATURES****WEIGHT**

Mod: 01:15 kg

Mod: 10:27 kg

**SIZE**

mm 340 x 760 x 115 h

**PVC POLE HOUSING EQUIPMENT** ☑

30 x 30 mm 50 x 50 mm 60 x 60 mm

**BATTERY HOUSING**

mm 180 x 150 x 150 h



# **GELAX**

*signalizacija & urbana oprema*

Zanatska 4, Plovanija  
52460 Buje /Croatia/

Tel/Fax: 00385 (0)52 777 144  
e-mail: [gelax@pu.htnet.hr](mailto:gelax@pu.htnet.hr)

[www.gelax.hr](http://www.gelax.hr)